

# BELT TYPE

## AIR COMPRESSOR OPERATING INSTRUCTION

IMPORTANT :

PLEASE READ CAREFULLY BEFORE STARTING OPERATIONS.  
THE CONTENTS ARE FOR GENERAL INFORMATION OF ALL THE  
SIMILAR MODELS.

Record these numbers in the space below and retain for future reference :

Power source : \_\_\_\_\_ V \_\_\_\_\_ Hz \_\_\_\_\_ Phase

Model No : \_\_\_\_\_

Serial No : \_\_\_\_\_

Purchased Date: \_\_\_\_\_

<b>TABLE OF CONTENTS</b>	<b>PAGE</b>
1 : IMPORTANT SAFETY INSTRUCTION -----	3-4
2 : GENERAL DESCRIPTION -----	5
3 : ON RECEIPT INSPECTION -----	5
4 : GENERAL REQUIREMENT -----	5
5 : INSTALLATION -----	5-7
6 : COMPRESSOR LUBRICATION -----	7
7 : START UP PROCEDURE -----	8
8 : MAINTENANCE CHECK LIST -----	9
9 : STORAGE -----	9
10 : TROUBLE SHOOTING -----	10-11

## 1 : IMPORTANT SAFETY INSTRUCTION

IMPROPER OPERATION OR MAINTENANCE OF THIS PRODUCT COULD RESULT IN SERIOUS INJURY AND PROPERTY DAMAGE.



**▲ WARNING**



PLEASE READ AND UNDERSTAND ALL INSTRUCTIONS BEFORE USING YOUR AIR COMPRESSOR.  
KEEP THIS BOOKLET FOR FUTURE REFERENCE.

### 1-1 : RISK OF FIRE



- DO NOT SPRAY COMBUSTIBLE OR FLAMMABLE LIQUID IN A CONFINED AREA, SPRAY AREA MUST BE WELL VENTILATED.
- DO NOT SMOKE WHILE SPRAYING OR SPRAY WHERE SPARK OR FLAME IS PRESENT.
- KEEP COMPRESSOR AT LEAST 12 ~ 18 FEET AWAY FROM SPRAYING AREA AND ALL EXPLOSIVE VAPORS.

### 1-2 : RISK OF ELECTRICAL SHOCK



- DISCONNECT COMPRESSOR FROM ELECTRICAL SUPPLY CIRCUIT BEFORE MAINTENANCE.
- DO NOT EXPOSE COMPRESSOR TO RAIN OR OPERATE IN A WET AREA.
- NEVER USE THE AIR COMPRESSOR WITHOUT CONNECTION TO A PROPERLY GROUNDED OUTLET WITH THE SPECIFIED VOLTAGE AND FUSE PROTECTION.
- IMPROPER GROUNDING CAN RESULT IN ELECTRICAL SHOCK.

### 1-3 : RISK OF EXPLOSION



- DRAIN TANK DAILY, CONDENSED WATER WILL CAUSE RUSTING AND RISK OF TANK RUPTURE OR EXPLOSION.
- DO NOT REPAIR · MODIFY OR WELD TANK, RETURN TO AUTHORIZED SERVICE CENTER IF REPLACEMENT IS REQUIRED.
- DO NOT ADJUST REGULATOR TO RESULT IN OUTPUT PRESSURE GREATER THAN MARKED MAX. PRESSURE OF ATTACHMENT.
- PRESSURE SWITCH IS SET AT THE FACTORY FOR OPTIMUM PERFORMANCE OF YOUR PARTICULAR MODEL, NEVER BYPASS OR REMOVE PRESSURE SWITCH AS SERIOUS DAMAGE TO EQUIPMENT OR PERSONAL INJURY COULD RESULT FROM IMPROPER PRESSURE SETTING.
- BEFORE STARTING COMPRESSOR, PULL PRESSURE RELIEF VALVE RING TO MAKE SURE THE VALVE MOVES FREELY. THE PRESSURE RELIEF VALVE IS FACTORY INSTALLED TO PREVENT THE AIR RECEIVER FROM DAMAGE SHOULD MALFUNCTION OCCUR IN THE PRESSURE SWITCH. IT IS FACTORY SET AT A SPECIFIC LIMIT FOR YOUR PARTICULAR MODEL. AND SHOULD NEVER BE TAMPERED WITH. ADJUSTMENT BY USER WILL AUTOMATICALLY VOID WARRANTY.

#### 1-4 : RISK OF BURNS



- HOT SURFACE CAN CAUSE SERIOUS INJURY. NEVER TOUCH ANY EXPOSED METAL PARTS ON COMPRESSOR DURING OR IMMEDIATELY AFTER OPERATION. TOUCHING THESE AREAS MAY CAUSE SEVERE BURNS.
- DO NOT REACH AROUND PROTECTIVE SHROUNDS OR ATTEMPT MAINTENANCE UNTIL UNIT HAS BEEN ALLOWED TO COOL.

#### 1-5 : RISK TO HEALTH



- USE RESPIRATORY PROTECTION IN A WELL VENTILED AREA WHEN SPRAYING.
- COMPRESSED AIR FROM THE UNIT MAY CONTAIN POISONOUS VAPOUR WHICH IS NOT SUITABLE FOR INHALEING AND COULD BE HARMFUL TO YOUR HEALTH.
- WORK IN AN AREA WITH GOOD VENTILATION.

#### 1-6 : RISK FROM MOVING PARTS



- UNIT STARTS AUTOMATICALLY, DO NOT OPERATE WITH BROKEN GUARDS OR COVERS REMOVED.
- ANY REPAIR REQUIRED ON THE PRODUCT SHOULD BE PERFORMED BY AUTHORIZED SERVICE CENTER PERSONNEL.
- DO NOT TOUCH MOVING PARTS.

#### 1-7 : RISK FROM FLYING OBJECTS

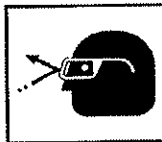

- ALWAYS WEAR ANSI Z87.1 APPROVED SAFETY GLASSES WITH SIDE SHIELDS WHEN USE THE AIR COMPRESSOR. ALWAYS WEAR PROPER SAFETY EQUIPMENT WHILE USING COMPRESSED AIR.
- DO NOT DIRECT HIGH PRESSURE AIR STREAM TOWARD ANY PARTS OF THE BODY OR AT OTHER PEOPLE.
- UNPLUG POWER CORD AND DRAIN AIR FROM TANK BEFORE SERVICING AND WHENEVER YOU LEAVE FOR THE DAY.

#### 1-8 : RISK OF PROPERTY DAMAGE WHEN TRANSPORTING COMPRESSOR



- ALWAYS PLACE COMPRESSOR ON A PROTECTIVE MAT WHEN TRANSPORTING TO PROTECT AGAINST DAMAGE TO VEHICLE FROM LEAKS.
- ALWAYS OPERATE COMPRESSOR IN A STABLE POSITION TO PREVENT ACCIDENTAL MOVEMENT OF THE UNIT.

## 2 : GENERAL DESCRIPTION OF AIR COMPRESSOR

The air compressor pump works with the up and down of a piston in the cylinder. During the down-stroke, ambient air is drawn in through the inlet valve, while the discharge valve remains closed. On the up-stroke of the piston, the air is forced into the compressor tank through the discharge valve and the check valve. Through this controlled action, air is forced into the tank to a preset pressure. The pressure switch regulates the pressure and controls the stop/start of motor. Working air is not available until the pressure in the air tank built up. The air inlet filter openings must be kept clear of obstructions.

All tools require specific air pressure to operate properly. Consult your air tool manual for those requirements and safety instructions. There are a variety of air tools available that will operate efficiently with this air compressor. For best results, always compare the air tool requirements to your compressor output specifications. A tool that requires a lot of continuous air, such as a sander, will not operate effectively with a small tank compressor. A tool that requires little air, such as a brad nail gun, will operate with a small tank compressor very effectively. Learn your air tool power requirements, match your air tools to your compressor correctly and this compressor will perform effectively.

## 3 : ON RECEIPT INSPECTION

Each air compressor outfit is carefully tested and inspected before shipment. Every attempt is made to ensure safe and complete shipment of our products. Please inform the dealers if any deficiency was found.

## 4 : GENERAL REQUIREMENT

Please ensure air compressor is installed correctly. Maintain and service on a regular basis. Information included in this booklet describing the maintenance schedules and trouble-shooting. It is important that you read this information and keep it for future reference.

## 5 : INSTALLATION

### 5.1 : MECHANICAL

Located the compressor in a clean, dry and well-ventilated area. The compressor should be located 12 ~ 18 inches from a wall or any other obstruction that would interfere with the air flow. Place the air compressor on a firm and level surface. The air compressor is designed with heat dissipation fins that allow for proper cooling. Keep the fins and other parts clean. A clean compressor runs cooler and provides longer service. Allow room for easy access to the air compressor for maintenance and service work.

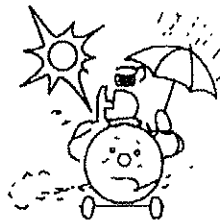

**DO NOT EXPOSE  
TO RAIN**

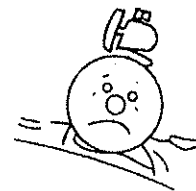

**DO NOT OPERATE  
ON UNLEVEL SURFACES**



**DO NOT PLACE  
IN A WET AREA**



**DO NOT PLACE IN A  
CONFINED AREA WHERE  
AIR FLOW IS RESTRICTED**

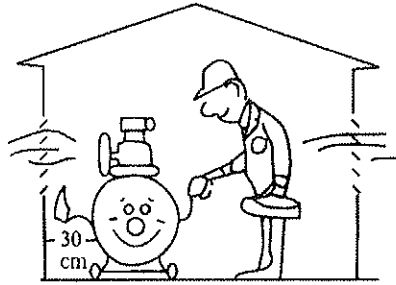

**PLACE IN A CLEAN, DRY  
AND WELL VENTILATED AREA**

**5.1-1 :** For vertical type permanent installation, the compressor should be bolted to the floor through holes provided in the compressor feet. Shims must be used to level the compressor before bolting it to the floor. Severe vibration will result when the compressor is bolted down tightly and the feet are not level. This can lead to welds cracking or fatigue of the air receiver.

**5.2 : ELECTRICAL**

Please ensure that the air compressor is electrically connected in a safe and correct manner. Any electrical work should be carried out by an electrician and installed in a way which meets all applicable codes and regulations.

Failure to connect the air compressor correctly to power source may result in serious personal injury or damage to the equipment.

Please note that under normal conditions, the air compressor will operate intermittently. Should it be necessary to service, ensure the power source has been shut down to prevent personal injury or damage to the unit.

If the supply cord is damaged, it must be replaced by the your dealer or its service agent in order to avoid a hazard.

**5-2-1 : MOTOR**

Wiring must be done in a manner that full voltage nameplate  $\pm 10\%$  is available at the motor terminals during startup. Use of an incorrect power source will result in premature motor failure and is not covered by this compressor or motor manufacturer's warranty.

**5-2-2 : PRESSURE SWITCH**

The pressure switch acts as a pilot device activating the motor. The pressure switch cut in/cut out has been preset at the factory, do not tamper with the settings. Never bypass or remove this switch, as serious damage to equipment or personal injury could result from improper pressure setting. Consult your local distributor or service center if the switch malfunctions.



### 5-2-3 : GROUNDING INSTRUCTIONS

Do not modify the plug that has been provided, if it does not fit the available outlet, the correct outlet should be installed by a qualified electrician. The plug must be plugged into an outlet that is properly installed and grounded in accordance with all local codes. If these grounding instructions are not completely understood or if in doubt as to whether the compressor is properly grounded, have the installation checked by a qualified electrician.

- 5-2-3-1 :** This product is for use on a nominal 115 or 230 volt circuit, as applicable. A cord with a grounding plug as shown here shall be used. Make sure that the product is connected to an outlet that matches the plug. No adapter should be used with this product.  
(FOR AREA OTHER THAN USA, PLEASE CHECK THE LOCAL CODE.)

### 5-2-4 : EXTENSION CORDS

The use of any extension cord will cause some drop in voltage and loss of power. For optimum performance, plug the compressor power cord directly into a grounded wall socket. Do not use an extension cord unless absolutely necessary. It is better to use a long air hose to reach area where work is being performance. If use of an extension cord can not be avoided, refer to the following guidelines :

Use only 3-wire extension cord that has a 3-blade grounding plug. Make sure your extension cord is in good condition. Be sure gauge is sufficient to carry the current the unit will draw. For length less than 50 ft, use 12 AWG extension cord. Note that the smaller the gauge the heavier the cord. Example: Gauge 10 is heavier than gauge 12. Do not use 14 or 16 AWG for extension cord.

### 5-2-5 : PUMP ROTATION

The compressor is to be wired in a manner that the rotation of the flywheel causes the air to be blown over the pump. This allows the pump to cool properly.

## 6 : COMPRESSOR LUBRICATION

Do not add or change oil while the compressor is in operation, use the recommended 30 weight non-detergent oil only.

### 6-1 : OIL FILLING

**6-1-1 :** Remove the oil filler plug.

**6-1-2 :** Slowly pour the proper oil into the pump crankcase.

**6-1-3 :** Always keep oil level between the marks "HIGH" and "LOW" level on the oil stick or on the red circle of the sight glass.

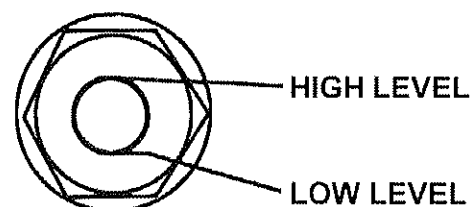
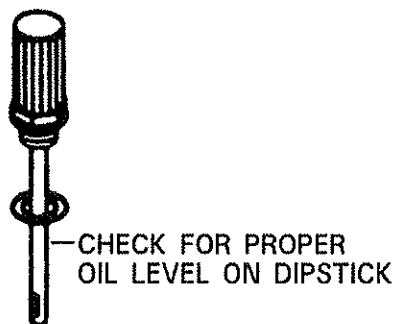

## 7 : START UP PROCEDURE

Do not attempt to operate the air compressor unit without first checking the oil level in the pump, add oil as required. Serious damage may result from use without oil.

7-1 : Check to see that nuts and bolts are all snug, this must be done as some fasteners may become loose in transit.

7-2 : Check to see if the belt is installed with proper tension.

7-3 : Check belt tightness so that when pressure is applied at the center, there is 1/2" slack.

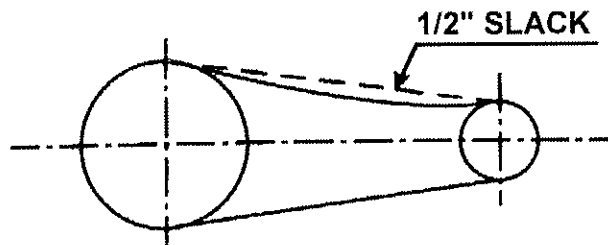

7-4 : Check that type and oil level is correct, use proper compressor lubrication.

7-5 : Check that compressor is placed on a strong, stable level ground.

7-6 : Check that crank case breather is clean.

7-7 : Check that air filter is clean.

7-8 : Do not place any materials on or against the compressor unit itself.

For doing so will limit the cooling of the air compressor and could lead to premature failure.

7-9 : Check that the flywheel is turning in the correct direction. For three phase power, switch any two wires if the rotation is incorrect.

7-10 : Open the air receiver outlet ball valve and start the unit. Allow the unit to operate for a minimum of twenty minutes in this no load condition.

7-11 : After running the compressor for twenty minutes, close the ball valve and allow the unit to reach maximum operating pressure. Ensure that the compressor shuts down at the preset maximum pressure, and the head pressure is released through pressure switch.

7-12 : Check the air compressor and piping systems for leakages, and correct as required.

7-13 : Shut off of all power to the air compressor before attempting any repair or maintenance.

7-14 : Stop the compressor and check the oil level thru oil gauge. Add oil as required.

7-15 : Your compressor is ready for use.



## 8 : MAINTENANCE CHECK LIST

### **WARNING**

Before doing any maintenance or adjustments to your air compressor, the following safety precautions should be taken.

**(1) : DISCONNECT ELECTRICAL POWER.**

**(2) : MAKE SURE NO PRESSURE IN AIR RECEIVER.**

#### **8-1 : Daily checklist**

**8-1-1 :** Check oil level.

**8-1-2 :** Drain condensation from air receiver tank.

**8-1-3 :** Check for any unusual noise or vibration.

**8-1-4 :** Be sure all nuts and bolts are tight.

#### **8-2 : Weekly checklist**

**8-2-1 :** Clean air filter . Replace air filter if necessary.

**8-2-2 :** Check oil level and filling up if necessary.

#### **8-3 : Quarterly or 300 hour checklist**

**8-3-1 :** Change compressor oil and filter element.

**8-3-2 :** Check condition and alignment of belt, flywheel and motor pulley.

Adjust belt tension if necessary or replace belt if worn.

**8-3-3 :** Check safety valve.

**8-3-4 :** Check pressure switch unloads to ensure compressor head unloads.

**8-3-5 :** Clean and blow off pump fins and motor.

**8-3-6 :** Inspect air system for leaks by applying soapy water to all joints. Tighten joints if leakages are observed.

## 9 : STORAGE :

### **WHEN YOU HAVE FINISHED USING THE AIR COMPRESSOR :**

**9-1 :** Set the "on/off" switch to "off" and unplug the cordially.

**9-2 :** Be sure to drain the water from the air tank.

**9-3 :** Protect the electrical cord and air hose from damage.

**9-4 :** Store the air compressor in a clean and dry location.

## 10 : TROUBLE SHOOTING :

CONDITION	CAUSE	CORRECTIVE
<b>Won't start</b>	<ul style="list-style-type: none"> <li>1 : Fuse blown or circuit breaker tripped</li> <li>2 : Loose electrical connection</li> <li>3 : Motor overheated</li> </ul>	<ul style="list-style-type: none"> <li>1 : Check for cause of blown fuse or breaker and replace or reset</li> <li>2 : Check wiring connection</li> <li>3 : Press reset button</li> </ul>
<b>Low pressure</b>	<ul style="list-style-type: none"> <li>1 : Malfunction in valves</li> <li>2 : Loose tube or fittings</li> <li>3 : Restricted air filter</li> <li>4 : V-belts loose</li> <li>5 : Defective check valve</li> <li>6 : Worn compression rings</li> </ul>	<ul style="list-style-type: none"> <li>1 : Check inlet and exhaust valves</li> <li>2 : Tighten fittings</li> <li>3 : Clean or replace</li> <li>4 : Adjust belts tension</li> <li>5 : Replace check valve</li> <li>6 : Replace rings</li> </ul>
<b>Pressure relief valve releasing continuously</b>	<ul style="list-style-type: none"> <li>1 : Defect pressure switch or improper adjustment</li> <li>2 : Defective pressure relief valve</li> </ul>	<ul style="list-style-type: none"> <li>1 : Check for proper adjustment if problem persists replace pressure switch</li> <li>2 : Replace valve</li> </ul>
<b>Oil discharge and excessive carbon formation or appearance of water and oil in the air lines</b>	<ul style="list-style-type: none"> <li>1 : Improper oil viscosity</li> <li>2 : Overfilling the crankcase with oil</li> <li>3 : Restricted air intake filter</li> <li>4 : Carbon on exhaust valves</li> <li>5 : Worn valves</li> <li>6 : Worn piston rings</li> <li>7 : High ambient temperature and/or humidity</li> <li>8 : Over usage of this compressor</li> </ul>	<ul style="list-style-type: none"> <li>1 : Use SAE 30 non-detergent compressor oil</li> <li>2 : Drain oil and fill to proper level</li> <li>3 : Clean or replace filter</li> <li>4 : Replace</li> <li>5 : Replace</li> <li>6 : Replace piston ring</li> <li>7 : Install a moisture separator and/or dryer follow by filter</li> <li>8 : Check for air leakage</li> </ul> <p>If no leaks are found you may required an additional compressor unit as air demand is too much for the existing unit</p>
<b>Belt roll off the flywheel or motor pulley</b>	<ul style="list-style-type: none"> <li>1 : Flywheel and motor pulley not aligned properly</li> <li>2 : Belts do not match flywheel / pulley groove</li> <li>3 : A nick or tear on the edge of the belt</li> <li>4 : Not a matched set(if two or more belts are used)</li> </ul>	<ul style="list-style-type: none"> <li>1 : Align using a straight edge</li> <li>2 : Purchase new set of matched belts</li> <li>3 : Purchase new set of matched belts</li> <li>4 : Purchase new set of matched belts</li> </ul>
<b>Water in air receiver tank</b>	<ul style="list-style-type: none"> <li>1 : Condensation in the air receiver</li> </ul>	<ul style="list-style-type: none"> <li>1 : Drain daily or install an automatic drain</li> </ul>

CONDITION	CAUSE	CORRECTIVE
<b>Compressor over heated</b>	1 : Undersized unit for air requirements 2 : Compressor location 3 : Pump rotating the wrong way 4 : Air leaks in the system 5 : Restricted air filter 6 : Improper grade or level of oil 7 : Worn, damage or carbon build up on valve 8 : Carbon build up at after-cooler tube or check valve	1 : Contact your compressor distributor 2 : See installation section 3 : See pump rotation 4 : Fix leaks 5 : Clean or replace filter 6 : Use SAE 30 non-detergent compressor oil 7 : Clean, repair or replace valves 8 : Clean or replace
<b>Excessive noise</b>	1 : Loose flywheel or motor pulley 2 : Loose valves 3 : Noisy only during start up, Check for loose belts 4 : Vibrating belt guard, piping 5 : Unit not installed level 6 : Improper grade of oil in crankcase 7 : Carbon or foreign material on piston 8 : Worn bearings	1 : Tighten as required 2 : Inspect valves for damage replace as required 3 : Adjust for proper tension 4 : Tighten as required 5 : Check if unit is mounted level 6 : Use SAE 30 non-detergent compressor oil 7 : Clean piston Check cylinder wall for scoring 8 : Replace bearings
<b>Pressure switch does not unload or leak air when unit is not operating</b>	1 : Pressure switch unloading may be dirty or faulty 2 : Check valve may be dirty or faulty	1 : Clean, repair or replace pressure switch 2 : Clean or replace check valve
<b>Oil leaks or appearance of oil on the compressor</b>	1 : Spillage of oil when filling 2 : Overfilling the crankcase 3 : Improper grade of oil 4 : Leak at oil filler plug 5 : Oil leak at gasket, cap screw, head, cylinder or crankcase 6 : Loose valve plugs 7 : Loose side or end plate 8 : Oil seal leak 9 : Scratch or burn on the crankshaft	1 : Wipe unit clean 2 : Drain oil and fill to proper level 3 : Use SAE 30 non-detergent compressor oil 4 : Tighten or replace oil filler plug and/or "O" ring 5 : Replace gaskets as required Use pipe dope or gasket compound on all cap screw threads 6 : Tighten valve plug 7 : Tighten plates 8 : Replace oil seal 9 : File or sand with emery cloth

## **LIMITED WARRANTY**

### **1 : Warranty conditions**

The warranty period of this machine is one year from the day of purchase.

### **2 : Contents of warranty**

In case of a trouble should occur during the warranty period and when it is determine that the trouble is causes clearly by our defective design, manufacture and/or execution of work, we repair or replace the parts free of charge without delay.

### **3 : Exceptions:**

Even during the warranty period of this machine, we refuse warranty in the following case :

- a : Trouble caused by the natural disasters or accident beyond human control.
- b : Trouble caused by defective materials selected or supplied by you, or caused by an improper application designated by you.
- c : Trouble caused by a repair or modification conducted by you without notifying us of the fact.
- d : Trouble caused by not complying to the operating procedures, periodical inspections, maintenance and storage, etc., described in the specification sheets and instruction manuals issued by us.
- e : Trouble caused by defective foundation, building and/or equipment other than this machine.
- f : Reduction of production due to a trouble of this machine, production compensation during the shutdown, and all other losses.

# MODEL : P55S (Pump)

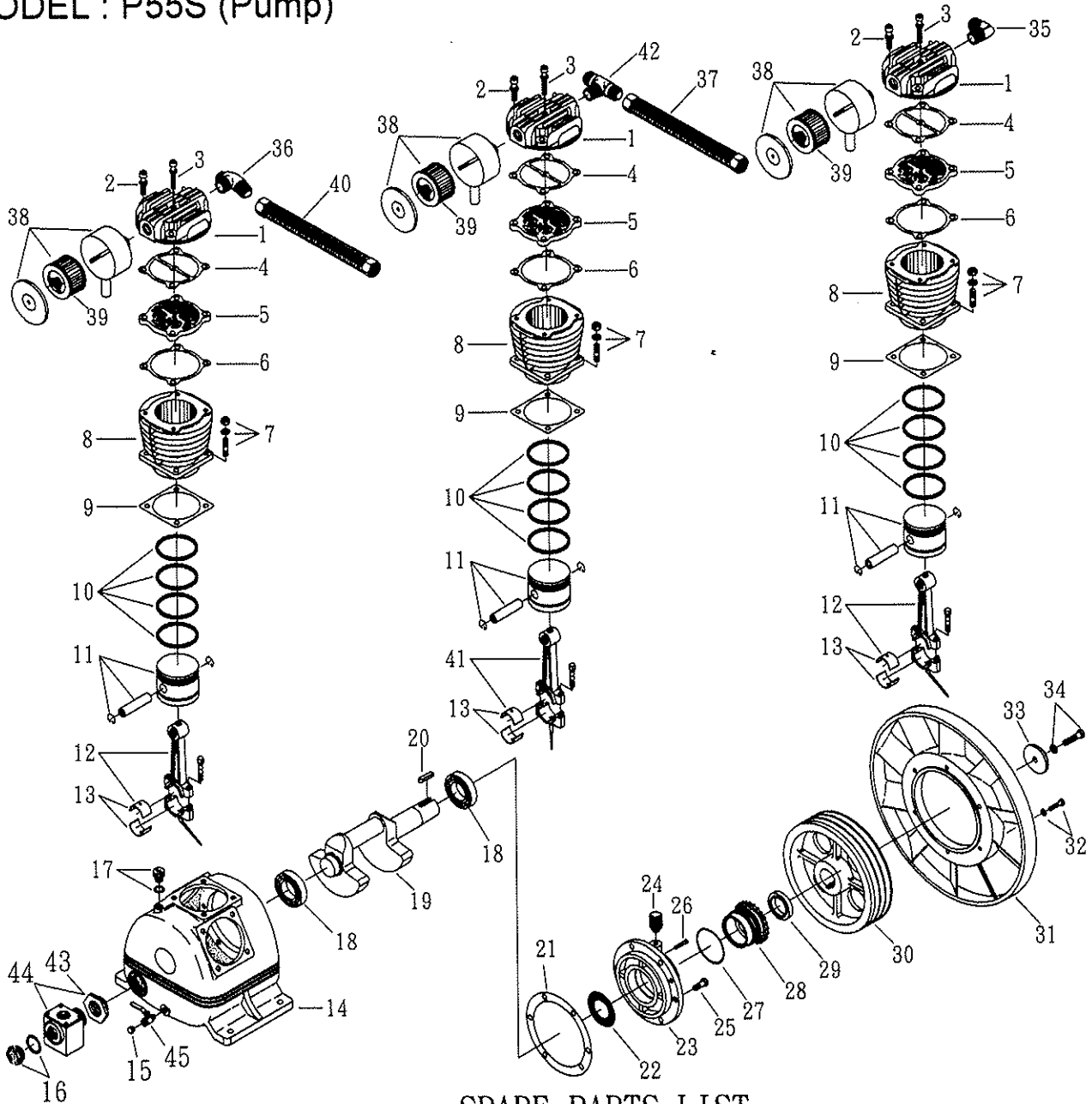

## SPARE PARTS LIST

NO : AGS-1007

REF. NO.	DESCRIPTION	PART NO.	QTY.	REF. NO.	DESCRIPTION	PART NO.	QTY.
1	Cylinder head	3101019	3	24	Breathing cover	2321008	1
2	Allen bolt set	3B01-M12*055V	12	25	Hexagon bolt	2B00-SM12*030	6
3	Allen bolt set	3B01-M08*055Z	3	26	Hexagon bolt	2B00-SM06*035	1
4	Cylinder head gasket	2G01-012	3	27	O-Ring	2N52-20*78	1
5	Inlet&Exhaust valve assembly	3B13-AP100	3	28	Thrust ring	3312002	1
6	Valve seat gasket	2G03-006	3	29	Oil seal	2N50-TC50*72*12	1
7	Double head screw set	3B11-004-A	3	30	Pulley	3PBF-115B350	1
8	Cylinder	3201016	3	31	Fly wheel	3PBF-516*228	1
9	Cylinder gasket	2G04-010	3	32	Hexagon bolt set	3B00-SM08*035AV	6
10	Piston ring set	3B32-100	3	33	Pulley washer	2B34-13*75*13	1
11	Piston set	3B31-100L	3	34	Hexagon bolt set	3B00-SM12*050V	1
12	Rod set	3B33-P7567	2	35	Exhaust elbow	2N06-10T10H	1
13	Crank rod bush(2 pieces)	2316002-B	3	36	Exhaust three way pipe	2N09-10H10T10H3	1
14	Crankcase	3301019B	1	37	Exhaust tube set	3B2-10*250	1
15	Oil draining plug	2N33-009	1	38	Air filter	2140011	3
16	Oil sight gauge set	2303004A	1	39	Filter element	2142009	3
17	Oil filling plug set	2319004A	1	40	Exhaust tube set	3B2-10*265	1
18	Bearing	2N35-32210	2	41	Rod set	3B33-P7568	1
19	Crankshaft & balancer	3304027	1	42	Exhaust three way pipe	2N09-10H10T10H4	1
20	Pulley key	2N47-10*8*40	1	43	Bushing	2N02-020	1
21	Rear bearing seat gasket	2G06-003	1	44	Low oil switch	3353102	1
22	Oil mesh	2352004	1	45	Ball valve	2413015	1
23	Rear bearing seat	3311007	1				

# MODEL :P55S (Receive Tank)

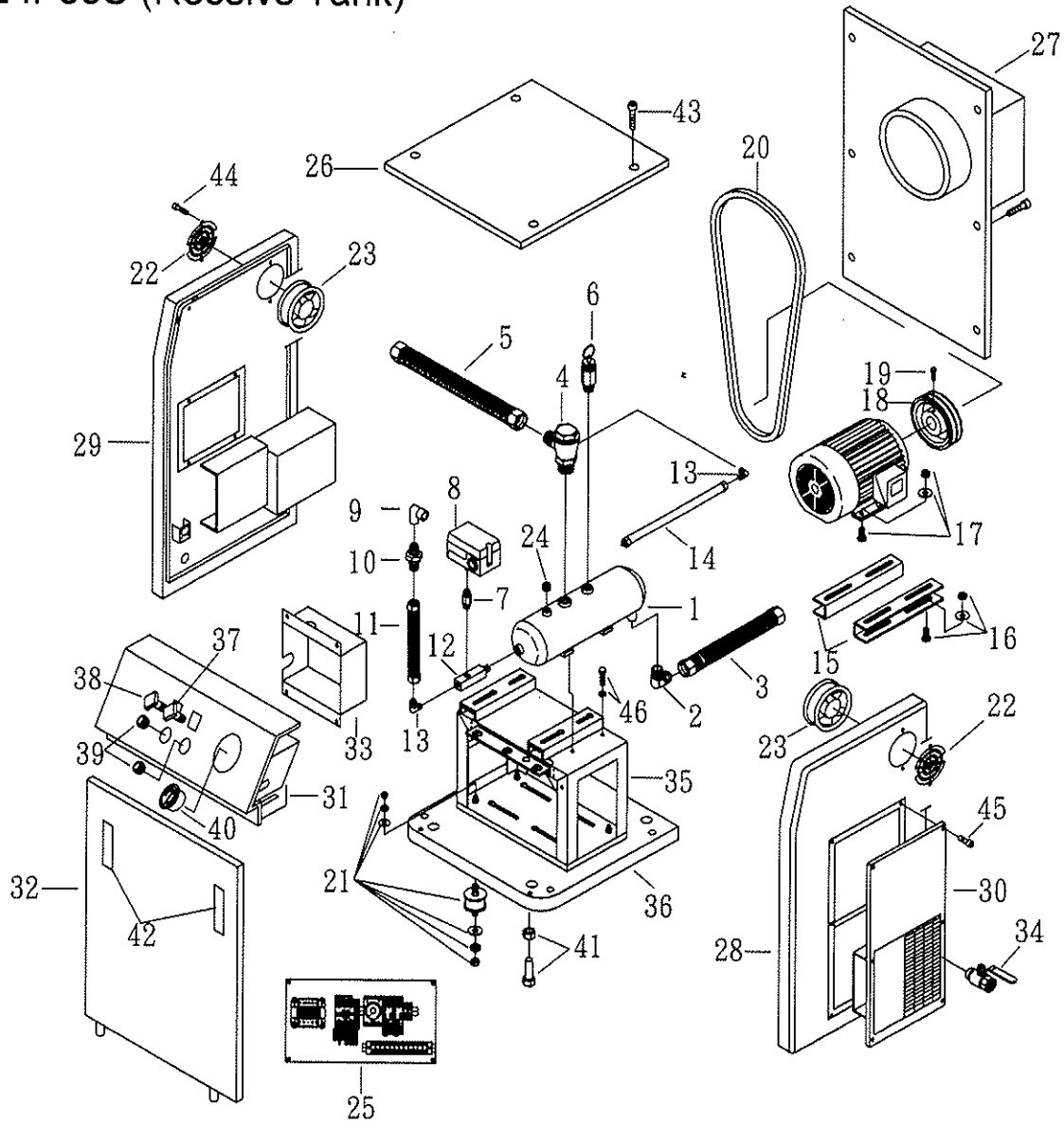

## SPARE PARTS LIST

NO: AGS-1007

REF. NO.	DESCRIPTION	PART NO.	QTY.	REF. NO.	DESCRIPTION	PART NO.	QTY.
1	Air tank	3401236	1	24	Plug	2B14-ST04E	1
2	Exhaust elbow	2N06-10T10H3	1	25	Magnetic switch	2E33-10*415	1
3	Exhaust steel wire soft tube	2T02-10*0550A	1	26	Top cover	2R11-071	1
4	Check valve	2414032	1	27	Rear	2R06-071	1
5	Exhaust steel wire soft tube	2T02-10*0700A	1	28	Side cover	2R03-071	1
6	Pressure relief valve	2406034	1	29	Side cover	2R04-071	1
7	Nipple	2N01-045	1	30	Maintenance cover	2R14-071	1
8	Pressure switch	2E21-024	1	31	Panel back cover	2R09-071	1
9	Exhaust elbow	2N07-02T02T	1	32	Front cover	2R09-071A	1
10	Nipple	2N01-005	1	33	Electrical box	2R18-071	1
11	Exhaust steel wire soft tube	2T02-02*0470	1	34	Ball valve	2413006	1
12	Bushing	2N02-029	1	35	Base frame	2R02-071	1
13	Unloading elbow	2N06-01T02H	2	36	Base frame	2R01-071	1
14	Unloading tube	3B2-02*600F	1	37	Start button	2D01-16F220G	1
15	Motor base	3421005	2	38	Stop button	2D01-16F220R	1
16	Motor feet bolt set	3B08-FM12*28-B	4	39	Light(Red)	2D02-16R220R	2
17	Motor feet bolt set	3B08-FM12*42-B	4	40	Pressure gauge	2D12-25B10K	1
18	Motor pulley	3PMF-062B3M3810	1	41	Hexagon bolt set	3B00-FW100*24N	4
19	Hexagon bolt	2B00-SM08*020	2	42	Handle set	2R12-004	1
20	V-belt	2N31-B61H	3	43	Allen bolt	2B01-M06*030	10
21	Vibration absorber set	3439007-A	4	44	Bolt	2B02-FM5*015	4
22	Fan net	2E31-0601	2	45	Bolt	2B02-FM6*015	10
23	Fan	2E30-0602	2	46	Hexagon bolt set	3B00-SM08*020V	2